

4

2

1

F

F

E

E

D

D

C

C

B

B

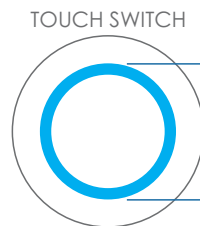
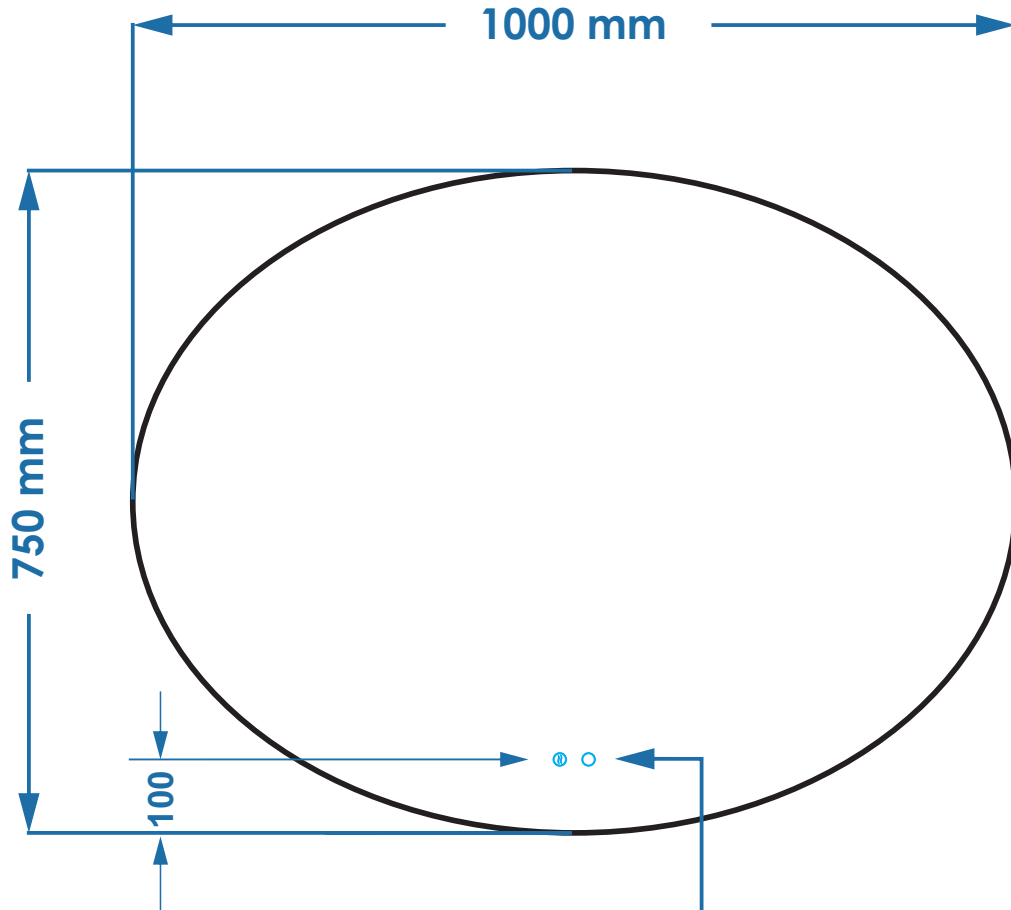

18 mm

DIMENSIONS ARE IN
MILIMETERS (mm)
DO NOT SCALE DRAWING

SIGNATURE/REVISION:

	NAME	SIGNATURE	DATE
DRAWN			
CHK D			
APPV D			
MFG			
A			

PRODUCT:	MIRROR
MATERIAL:	GLASS
THICKNESS:	4mm
EDGING:	C / F edge
SANDBLASTING:	NO <input type="checkbox"/>
SNESOR/SWICHTH:	TOUCH

TITLE:	<h1>Oval</h1>	
DIMESIONS:	1000 x 750 mm	A4
SCALE:	1 : 10	SHEET 1 OF 1

4

2

1

A

A